

CARACTERÍSTICAS / FEATURES

Material hormigón Petra 1 + hierro imprimación antioxidante + retroreflectantes
Acabado decapado e hidrofugado
Dimensiones Ø 81,61, h. 130,11 cm
Color ver carta de colores
Fijación apoyado por su propio peso o mediante resina epoxi
Peso 824 Kg
Palet 90 x 90 cm

Material precast concrete Petra 1 + iron with rust-resistant primer + retroreflective
Finish scaled and waterproofed
Dimensions Ø 81,61, h. 130,11 cm
Colour see colour catalogue
Fixing resting on the ground or with epoxy resin
Weight 824 Kg
Pallet 90 x 90 cm

diseñador / design: Ton Riera

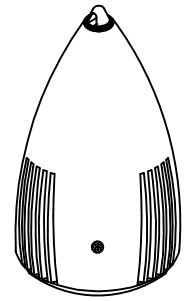

MAGNUM

GEOMETRIA / GEOMETRY

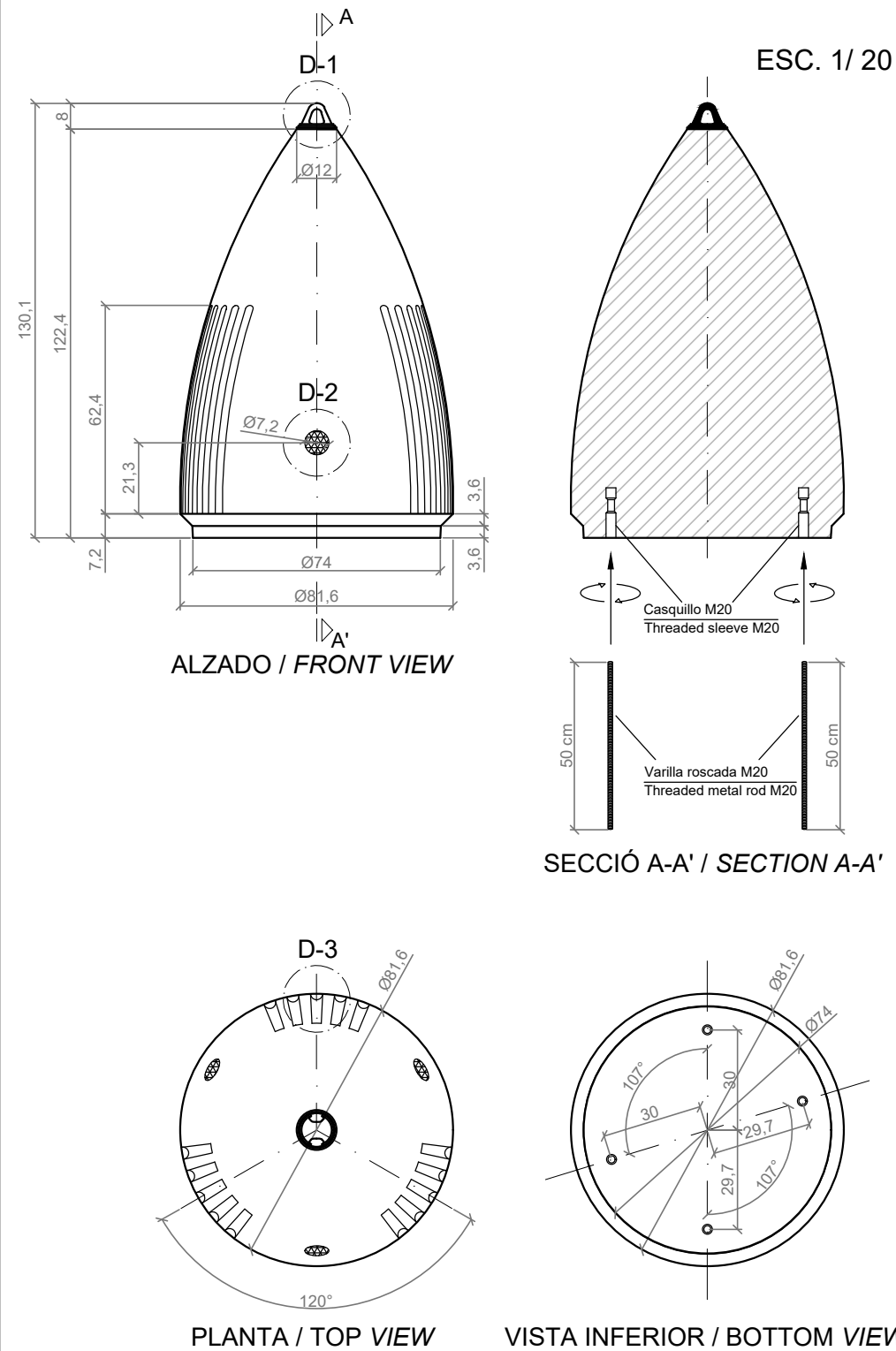

ESPECIFICACIONES / SPECIFICATIONS

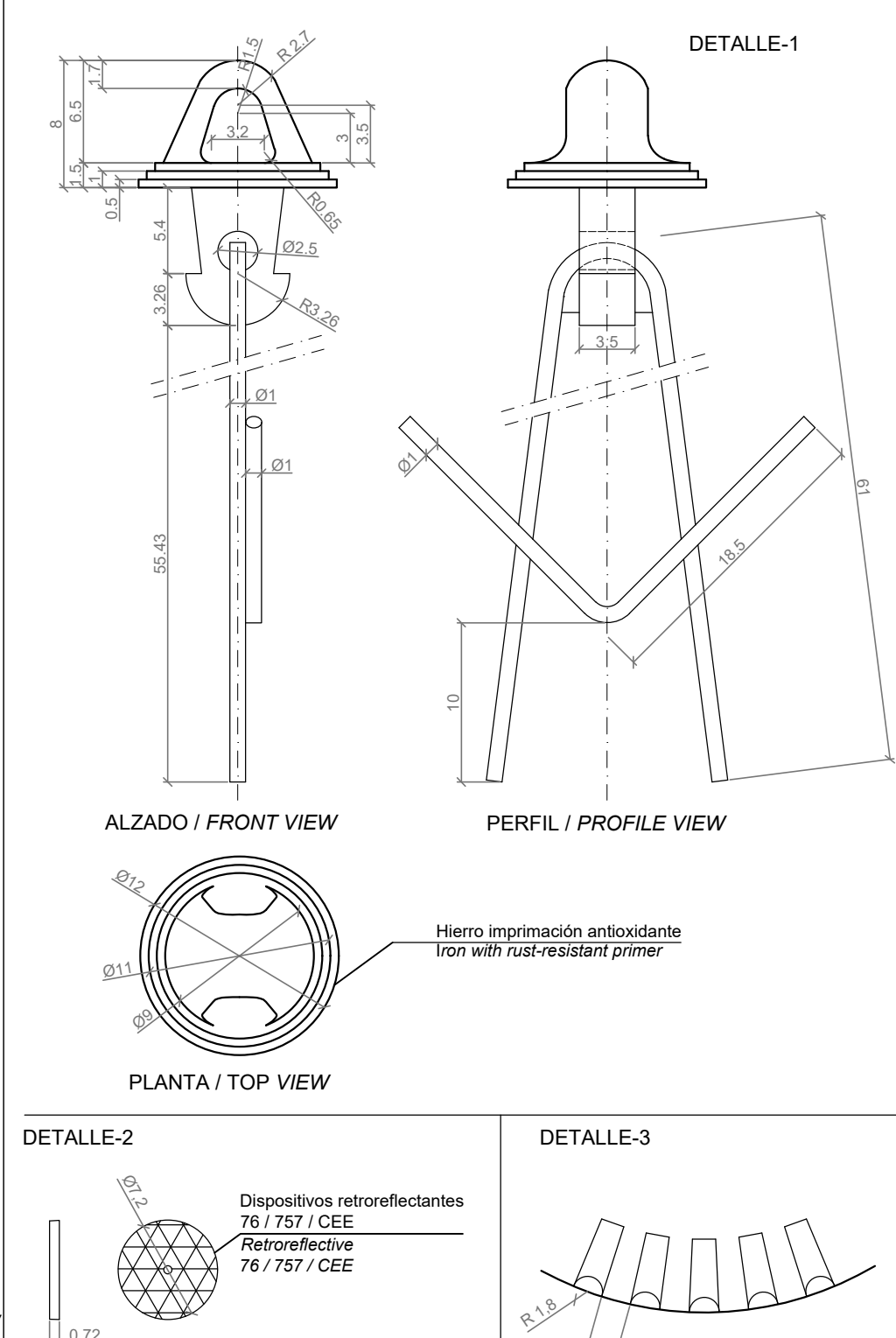

MANIPULACIÓN E INSTALACIÓN / HANDLING AND INSTALLATION

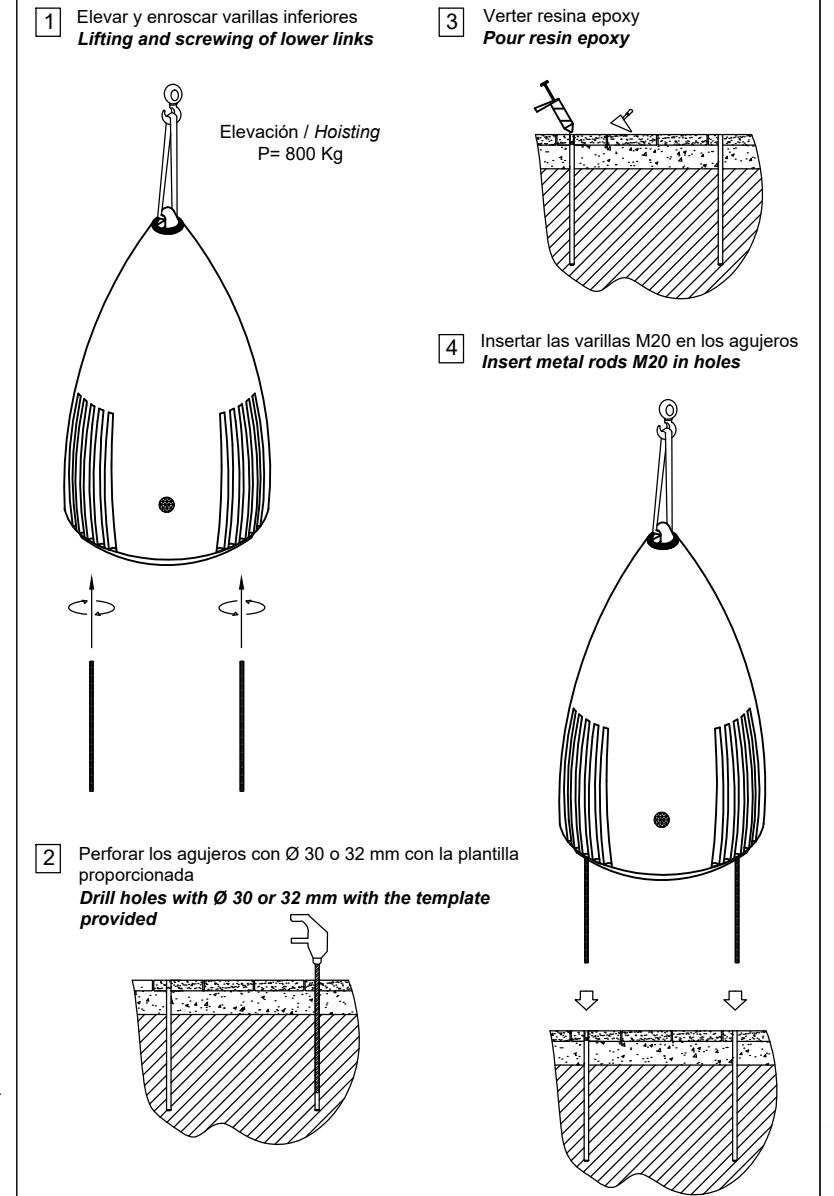

Tàrrrega, Lleida - Tel. +34 973 15 87 03 - www.magourban.com - info@magourban.com

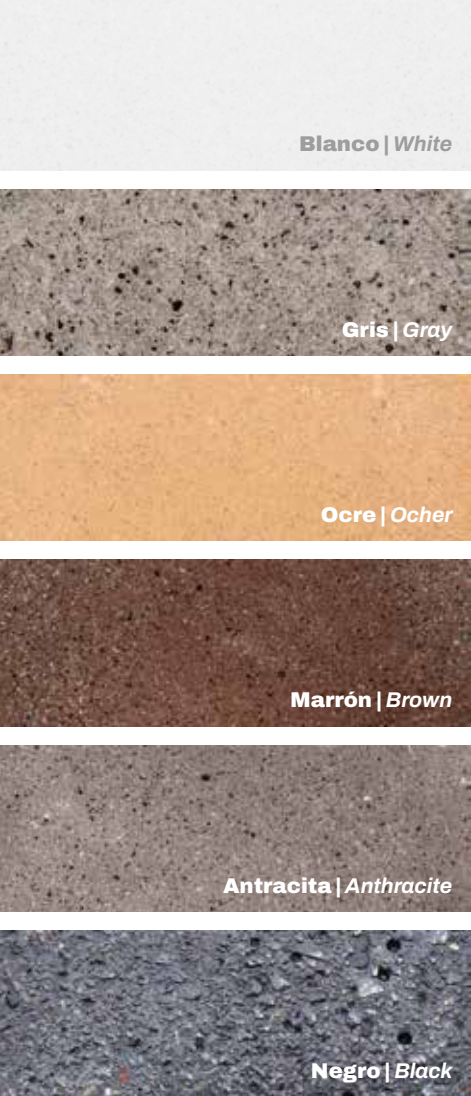

Blanco | White

Gris | Gray

Ocre | Ocher

Marrón | Brown

Antracita | Anthracite

Negro | Black

colores | colours



Amarillo | Yellow

Naranja | Orange

Rojo | Red

Azul | Blue

Verde | Green

colores opcionales (más colores disponibles)
optional colours (more available colours)

Petra 1

Personalizable
Customisable

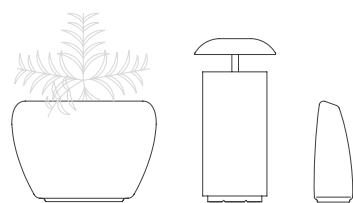
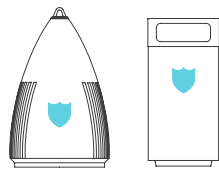

acabados de superficie

Disponibles en:
jardineras, recogida de residuos y límites

surface finishes

Available:
planters, waste collection and bollards



Corten



Negro Grafito | Black Graphite

SMC (UHPC)

acabado liso + antigraffiti

smooth finish + antigraffiti

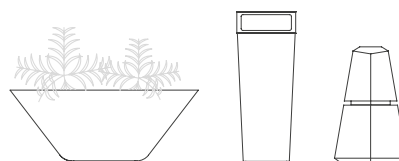

acabados de superficie

Disponibles en:
jardineras, recogida de residuos y límites

surface finishes

Available:
planters, waste collection and bollards



Corten



Golden



Bronce | Bronze



Negro Grafito | Black Graphite

colores | colours

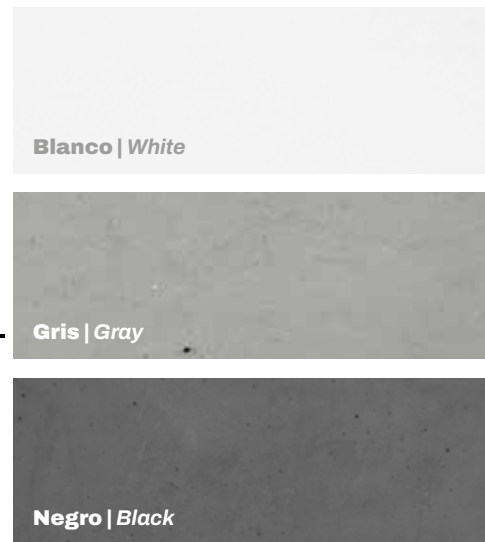

Blanco | White

Gris | Gray

Negro | Black