

NEW



VELOSPRING

RACK À VÉLO

○ BICYCLE RACK ○ ARARCA BICICLETA ○ FAHRRADSTÄNDER

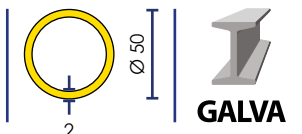

- Modèle fabriqué avec tube d'acier galvanisé Ø 50 mm – Hauteur 915 mm
- Monté sur platine de fixation décentrée (140 x 140 mm)
- 4 trous de fixations Ø 14 mm
- Pour versions 5, 6 vélos ou fabriquées en acier inoxydable, nous consulter.

- Model made with Ø 50 mm galvanized steel tube – Height 915 mm
- Mounted on an off-centre fixing plate (140 x 140 mm)
- 4 fixing holes Ø 14 mm
- For versions with 5 or 6 bicycles, or versions made of stainless steel, please contact us.

- Modelo fabricado con tubo de acero galvanizado de Ø 50 mm – Altura 915 mm
- Montado sobre placa de fijación descentrada (140 x 140 mm)
- 4 orificios de fijación de Ø 14 mm
- Para versiones de 5 o 6 bicicletas fabricadas en acero inoxidable, consúltenos.

- Modell aus verzinktem Stahlrohr 50 mm – Höhe 915 mm
- Montiert auf versetzter Befestigungsplatte (140 x 140 mm)
- 4 Befestigungslöcher Ø 14 mm
- Für Ausführungen mit 5 oder 6 Fahrrädern oder aus Edelstahlbitte Rücksprache mit uns halten.

VELO SPRING2 GAL  **6.50**

VELO SPRING4 GAL  **9.40**

VELO SPRING6 GAL  **12.7**



VELO SPRING8 GAL  **16**

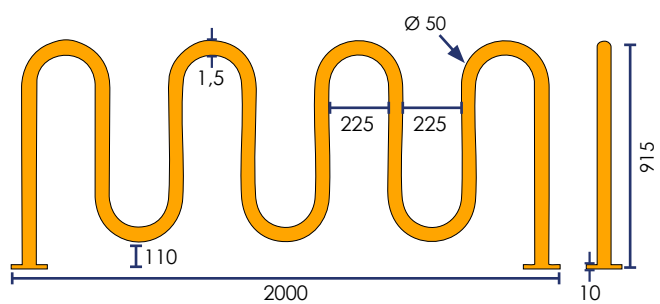

OPTION ○ OPTIONAL ○ OPCIÓN ○ OPTIONAL



FSAFE 4 SB
Ø 12 x 120

Buff'Hyères
Collectivités
MOBILIERS & AMÉNAGEMENTS URBAIN
06 32 46 92 74 - MOBILIER@BHC83.FR



NEW



VELORING



VELO 795 GAL

ÉPINGLE À VÉLO ◦ U-SHAPED BIKE RACK
 ◦ HORQUILLA APARCA BICICLETA ◦ FAHRRADSTÄNDER



GALVA



Ø 40 mm

2,70



300 x 690

BAR 34 GAL



Ø 40 mm

3,10



500 x 690

BAR 54 GAL



Ø 50 mm

6,10



350 x 915

VELO SPRING2 GAL



Ø 50 mm

6,90

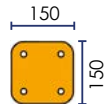

VELO 755 GAL

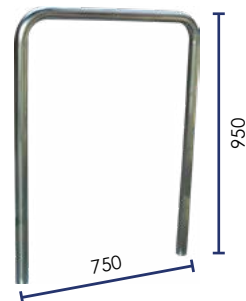

Ø 50 mm

7,50

VELO 795 GAL



Ø 50 mm

6,50

VELO 950 GAL



Ø 40 mm

6,90



RAL 9005

VELORING

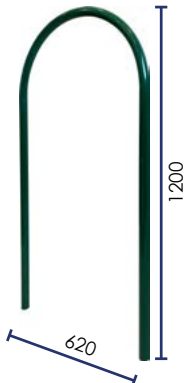

Ø 40 mm

3,5



RAL 6005

POT 162 V



Ne pas installer en milieu salin ou Hydrocarbure. Nous consulter.
 Do not install in saline or Oil environment. Contact us.
 No lo instale en un ambiente salino o hidrocarburo. Consúltenos.
 Soll nicht in Salz oder Kohlenstoff Umgebung installiert werden, /uns Konsultieren.

Sauf ◦ Except
 ◦ Salvo ◦ Nur



NEW



VELINOX 800

VELOPINS

RACK À VÉLO ◦ BICYCLE RACK ◦ APARCA BICICLETA ◦ FAHRRADSTÄNDER



VELOPINS 1000FIX

Ø 32 mm

4

↕ ↗

400 x 1000



1 - 2



VELOPINS 1200

Ø 32 mm

3,50

↕ ↗

400 x 1200



1 - 2





VELINOX 800

Ø 50 mm

6,50

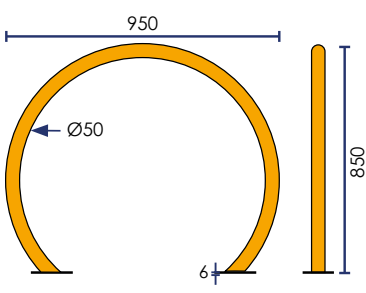

1 - 2



BARVELOCARGO

Ø 50 mm

4,80

↕ ↗

1200 x 300

3 x Ø 14



Ø 180

GALVA

RAL 9005





VELO 75 KIT

VELO 75 KIT

SUPPORT VÉLO MODULAIRE ◦ MODULAR BICYCLE SUPPORT
 ◦ SOPORTE MODULAR PARA ◦ MODULARE FAHRRADSTÜTZE

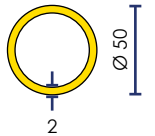

INSTALLATION EN LIGNE ◦ ONLINE INSTALLATION
 ◦ INSTALACIÓN EN LÍNEA ◦ ONLINE-INSTALLATION

INSTALLATION EN QUINCONCE ◦ STAGGERED INSTALLATION
 ◦ INSTALACIÓN ESCALONADA ◦ VERSETZTE INSTALLATION

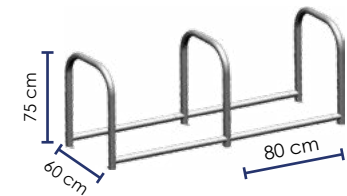

VELO 753 LDFIX

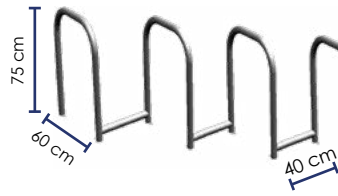

VELO 754 SSFIX



VELO 754 MSFIX



VELO 754 LD FIX



VELO 754 LSFIX

Code		
VELO 753 LD FIX	6	175 X 60 X 75
VELO 754 LD FIX	8	260 X 60 X 75

Buff'Hyères
 Collectivités
 MOBILIERS & AMÉNAGEMENTS URBAIN
 06 32 46 92 74 - MOBILIER@BHC83.FR

Code		
VELO 754 LS FIX	8	140 X 60 X 75
VELO 754 MS FIX	8	260 X 60 X 75
VELO 754 SS FIX	8	260 X 60 X 75

COMPOSANTS

◦ COMPONENTS ◦ COMPONENTES ◦ KOMPONENTEN

Code	
VELO 75400	400 (50 + 300 + 50)
VELO 75600	600 (50 + 500 + 50)
VELO 75800	800 (50 + 700 + 50)



VELO 75 SIM



VELO 75 DUO



VELO 75 TRI



INCLUS ◦ INCLUDED
 INCLUIDO ◦ INKLUSIVE



X 2

Pour assemblage ◦ For assembly
 ◦ Para montaje ◦ Zur Montage

OPTION ◦ OPTIONAL
 OPCIÓN ◦ OPTIONAL



BAR FIX 1 SB

Pour fixation au sol ◦ For floor mounting
 ◦ Para fijación al suelo ◦ Zur Bodenmontage

Code	
VELO 75	600 x 750

INCLUS ◦ INCLUDED ◦ INCLUIDO ◦ INKLUSIVE



NEW

VELINOX 900

VELOSTAND

RACK À VÉLO ◦ BICYCLE RACK ◦ APARCA BICICLETA ◦ FAHRRADSTÄNDER



Buff'Hyères

collectivités

MOBILIERS & AMÉNAGEMENTS URBAIN

06 32 46 92 74 - MOBILIER@BHC83.FR

10 ≤  ≤ 14

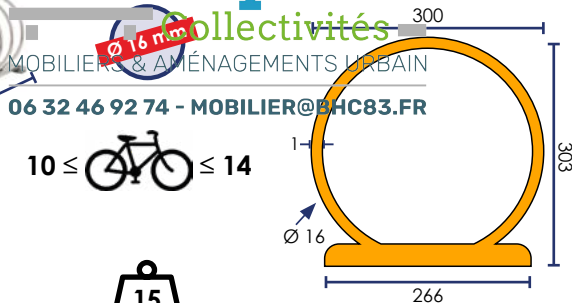
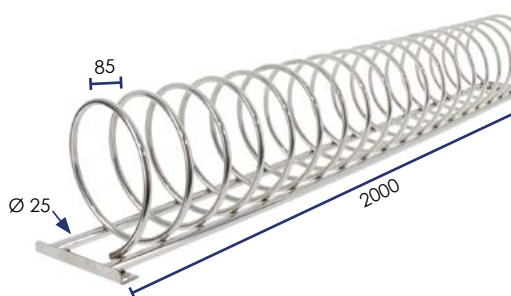

VELOSTAND



Ø 19 mm



1145 x 900



2 - 4

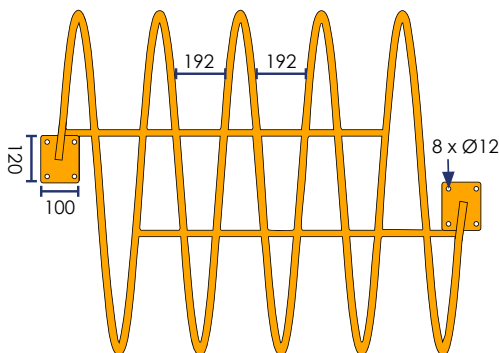

VELINOX 900



Ø 19 mm



1162 x 600



3 - 6

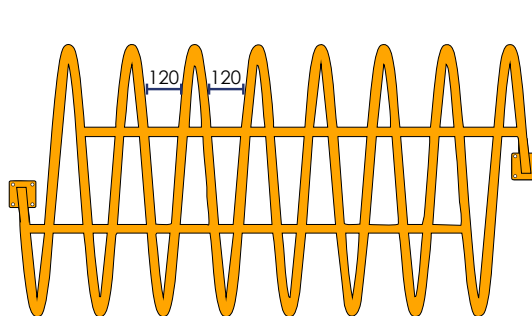

VELINOX 600



VELO 5 H

VELO 5

Code		
VELO 101	1	120 x 300 x 220
VELO 202	2	448 x 300 x 220
VELO 303*	3	766 x 300 x 220
VELO 404*	4	1088 x 300 x 220
VELO 5	5	1400 x 300 x 215



ZINGUÉ
ZINC
CINCADO
VERZINKTEM

* En kit ◦ In kit ◦ En kit ◦ als Bausatz

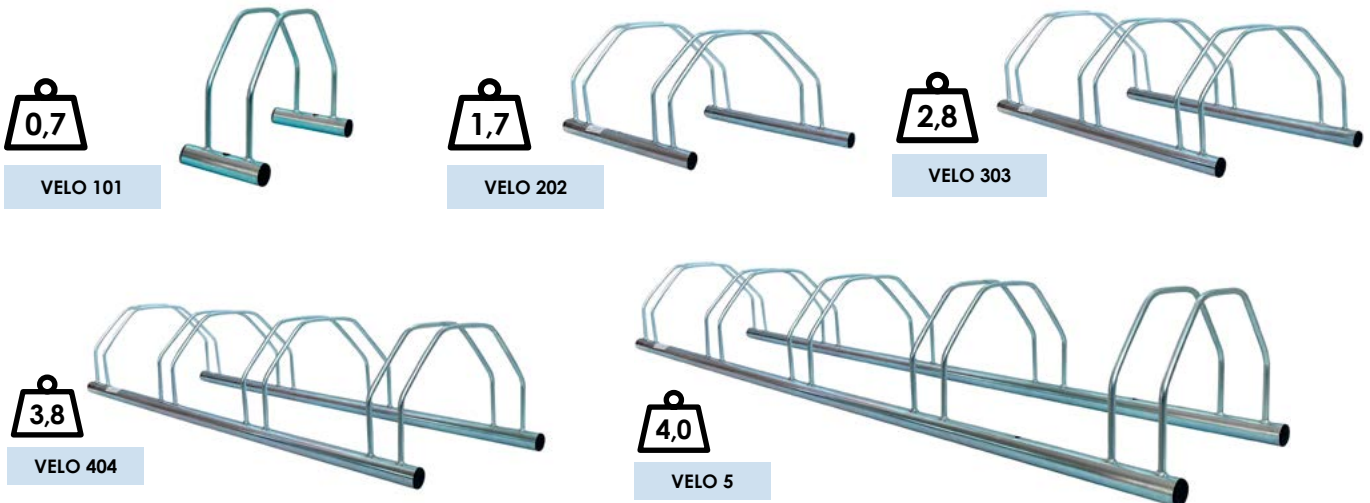

Code			
VELO 5 H	5	1543 x 317 x 703	9

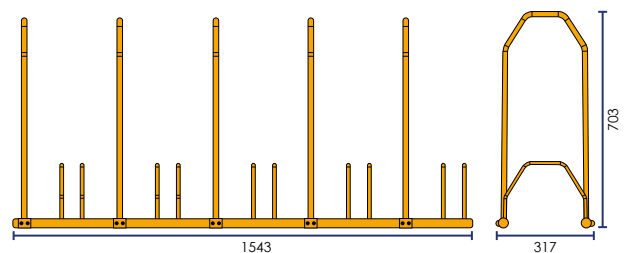

INCLUS
INCLUDED ◦ INCLUIDO ◦ INKLUSIVE

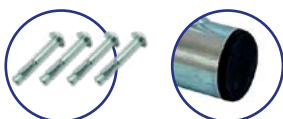

Buff'Hyères
Collectivités

MOBILIERS & AMÉNAGEMENTS URBAIN

06 32 46 92 74 - MOBILIER@BHC83.FR

NEW

VELOWALL

VELOWALL

SUPPORT VÉLO MURAL ORIENTABLE
 ADJUSTABLE WALL-MOUNTED BICYCLE RACK
 SOPORTE DE BICICLETA MURAL ORIENTABLE
 WANDBEFESTIGTER, VERSTELLBARER FAHRRADHALTER

ZINGUÉ
 ZINC
 CINCADO
 VERZINKTEM

Code		
VELOWALL	1	97 x 328 x 342
VELOWALL 3	3	1092 x 331 x 342

Ø 16 mm

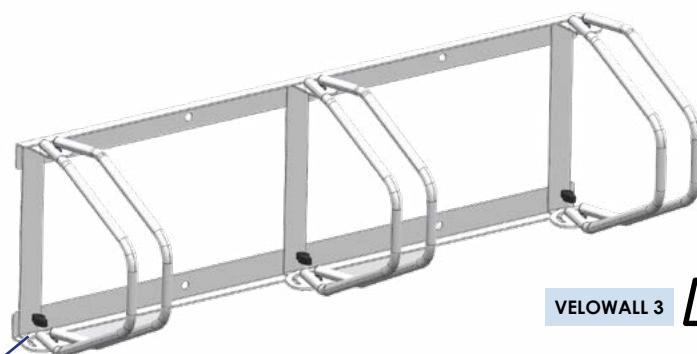
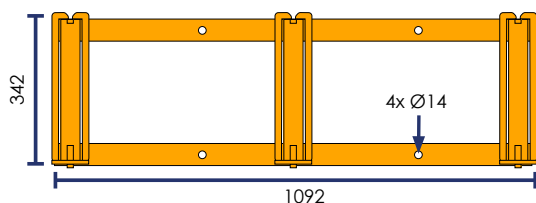

VELOWALL 3 **6,8**

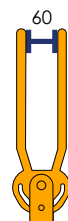
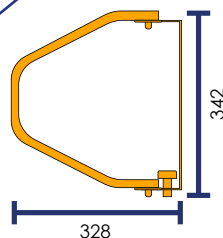

1,7

VELOWALL

VELO 5 W

Code			
VELO 5 W	5	1340 x 500 x 670	5,6

SUPPORT MURAL 5 VÉLOS
 WALL SUPPORT FOR 5 BIKES
 SOPORTE DE PARED PARA 5 BICICLETAS
 WANDBEFESTIGTER FÜR 5 FAHRRÄDER

ZINGUÉ
 ZINC
 CINCADO
 VERZINKTEM

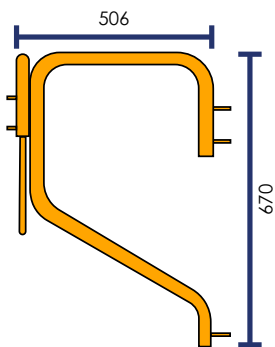

Crochet garni PVC
 PVC coated hook
 Gancho forrado de PVC
 Mit PVC ausgekleideter Haken



Buff'Hyères
 Collectivités

MOBILIERS & AMÉNAGEMENTS URBAIN

06 32 46 92 74 - MOBILIER@BHC83.FR

NEW



VELO

RACK À VÉLO ○ **BICYCLE RACK**
○ **PARKING BICICLETA** ○ **FAHRRADSTÄNDER**



OPTION
OPTIONAL
OPCIÓN
OPTIONAL



FSAFE 4 SB
Ø 12 x 120

- Modèle livré en kit avec tube d'acier galvanisé Ø 16 mm
- Les supports vélos sont à fixer sur les différents cadres, les cadres sont également à fixer entre eux (fixations incluses)
- Les fixations au sol sont en option.
- Model supplied as a kit with Ø 16 mm galvanized steel tube.
- The bicycle racks are to be fixed to the various frames, which are also to be fixed together (fixings included).
- Ground fixings are optional
- Modelo suministrado en kit con tubo de acero galvanizado de Ø 16 mm.
- Los soportes para bicicletas deben fijarse a los distintos bastidores, que también deben fijarse entre sí (fijaciones incluidas).
- Las fijaciones al suelo son opcionales.
- Modell wird als Bausatz mit verzinktem Stahlrohr Ø 16 mm geliefert.
- Die Fahrradhalterungen sind an den verschiedenen Rahmen zu befestigen, die Rahmen sind ebenfalls miteinander zu verbinden (Befestigungsmaterial im Lieferumfang enthalten).
- Die Bodenbefestigungen sind optional erhältlich.

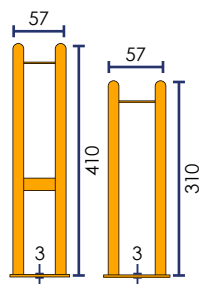

VELO 2



x 2

900 x 410 x 440



VELO 3



x 3

1125 x 410 x 440

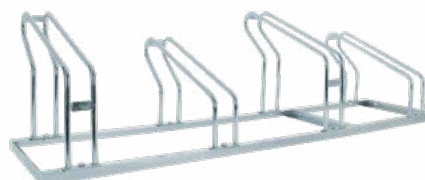

VELO 4



x 4

1575 x 410 x 440



VELO 5 FRA



x 5

2025 x 410 x 440



VELO 6



x 6

2475 x 410 x 440



VELO 7



x 7

2925 x 410 x 440

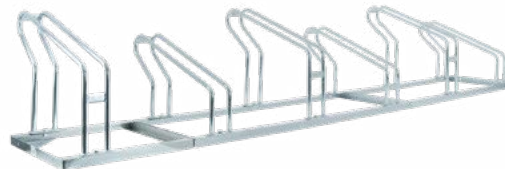

VELO 8



x 8

3375 x 410 x 440

NEW



VELO

RACK À VÉLO ○ BICYCLE RACK
○ PARKING BICICLETA ○ FAHRRADSTÄNDER



GALVA

OPTION
OPTIONAL
OPCIÓN
OPTIONAL



FSAFE 4 SB
Ø 12 x 120

- Modèle livré en kit avec tube d'acier galvanisé Ø 16 mm
- Les supports vélos sont à fixer sur les différents cadres, les cadres sont également à fixer entre eux (fixations incluses)
- Les fixations au sol sont en option.

- Model supplied as a kit with Ø 16 mm galvanized steel tube.
- The bicycle racks are to be fixed to the various frames, which are also to be fixed together (fixings included).
- Ground fixings are optional

- Modelo suministrado en kit con tubo de acero galvanizado de Ø 16 mm.
- Los soportes para bicicletas deben fijarse a los distintos bastidores, que también deben fijarse entre sí (fijaciones incluidas).
- Las fijaciones al suelo son opcionales.

- Modell wird als Bausatz mit verzinktem Stahlrohr Ø 16 mm geliefert.
- Die Fahrradhalterungen sind an den verschiedenen Rahmen zu befestigen, die Rahmen sind ebenfalls miteinander zu verbinden (Befestigungsmaterial im Lieferumfang enthalten).
- Die Bodenbefestigungen sind optional erhältlich.

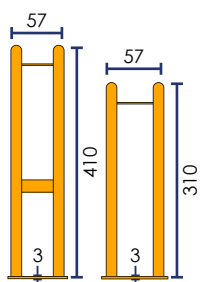

VELO 11



x 2



VELO 22



x 4

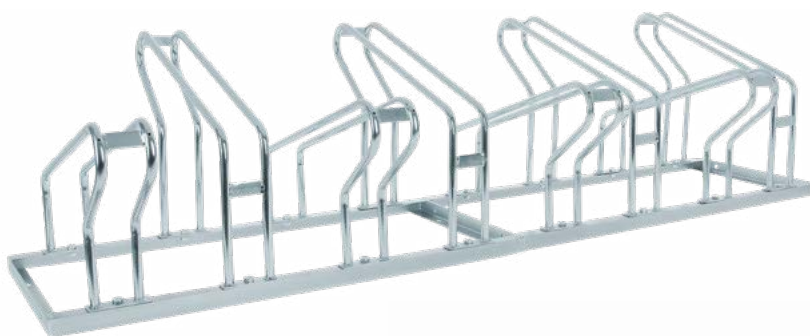

VELO 42



x 8

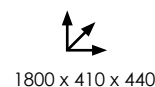

VELO 52



x 10



2250 x 410 x 440

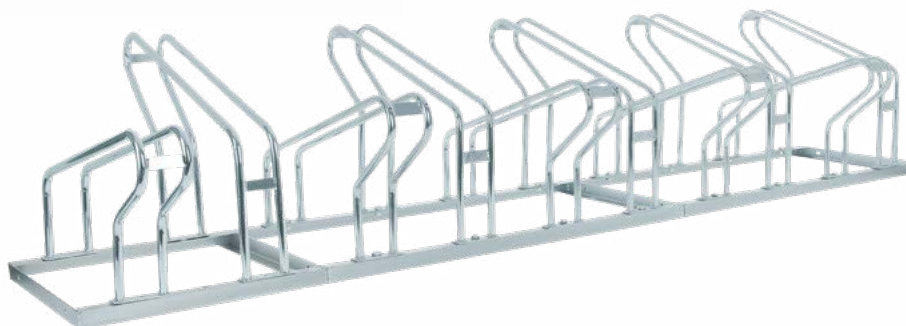

NEW



VELOBAR10PLI



VELOPARK

RACK À VÉLOS ÉVÈNEMENTIEL ○ **EVENT BICYCLE RACK**
 ○ **APARCABICICLETAS PARA EVENTOS** ○ **FAHRRADSTÄNDER FÜR VERANSTALTUNGEN**

VELOPARK

Code		
VELOPARK	9	1520 x 927 x 740

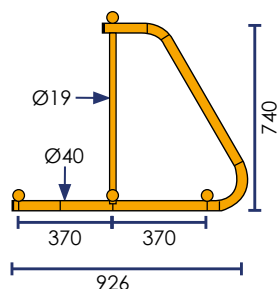
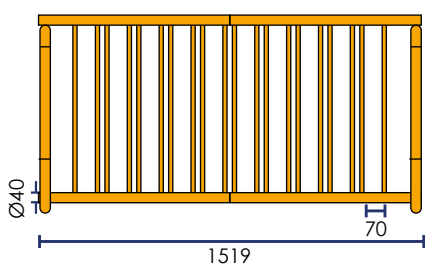

19

VELOPARK

4 x trous de fixation
 fixing holes
 agujeros de fijación
 Befestigungslöcher



VELOBAR10PLI

Code		
VELOBAR10PLI	10	2000 x 400 x 1000 2000 x 70 x 1000 Pliée ○ FOLDED ○ doblada ○ gefalten

22,6



VELOBAR11FIX

Code		
VELOBAR11FIX	10	2000 x 600 x 1000

21,6



NEW



VELOOROOF



VELOLIFT

VELOOROOF

ABRI VÉLOS
BICYCLE SHELTER
MARQUESINA PARA BICICLETAS
FAHRRADUNTERSTAND

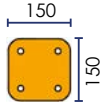

OPTION OPTIONAL
OPCIÓN OPCIÓNAL



FIX 1 SB
Ø 12 x 130



Buff'Hyères

Collectivités

MOBILIERS & AMÉNAGEMENTS URBAIN

06 32 46 92 74 - MOBILIER@BHC83.FR



VELOLIFT

RANGE VÉLOS 2 ÉTAGES
2-LEVEL BIKE RACK
APARCABICICLETAS DE 2 NIVELES
2-STUFIGER FAHRRADSTÄNDER

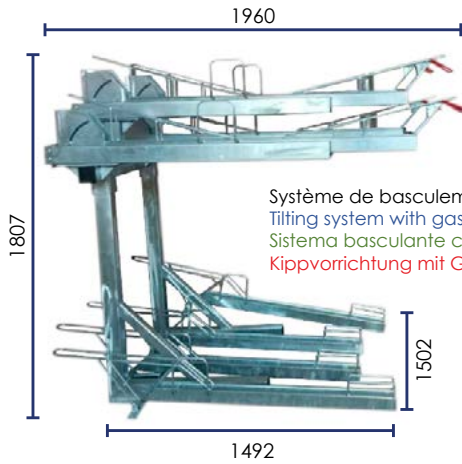

Système de basculement avec vérin à gaz
Tilting system with gas cylinder
Sistema basculante con cilindro de gas
Kippvorrichtung mit Gasdruckfeder



OPTION OPTIONAL
OPCIÓN OPCIÓNAL



FIX 1 SB





RAMPVELO



SCOOTER 7

RACK À TROTINETTE ◦ **SCOOTER RACK**
 ◦ **APARCA PATINETES** ◦ **PARKSTÄNDER FÜR SCOOTER**



RAL 9005



PEINTURE ÉPOXY
 POWDER PAINTING
 PINTURA EPOXICA
 EPOXY FARBE

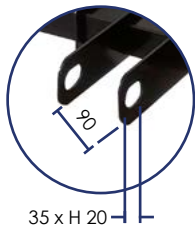
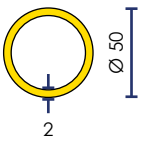

Bords arrondis
 Rounded edges
 Borde redondeados
 Abgerundete Ecken

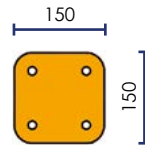
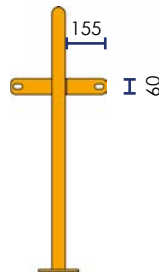
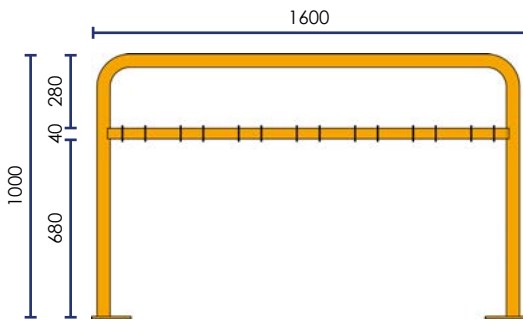

OPTION
 OPCIÓN
 OPTIONAL



x 8
BARFIX 8 SB
 Ø 12 x 120

RAMPE D'ACCÈS POUR CYCLE ◦ **ACCESS RAMP FOR CYCLE**
 ◦ **RAMPA DE ACCESO PARA BICICLETAS** ◦ **ZUFahrtsRAMPE FÜR FAHRRÄDER**

Code			
RAMPVELO	1930 x 168 x 50	200	4,0



INCLUS ◦ **INCLUDED** ◦ **INCLUIDO** ◦ **INKLUSIVE**





Sac de transport
 Transport bag
 Bolsa de transporte
 Transporttasche



**CONSULTEZ-NOUS POUR TOUTES
VOS DEMANDES DE DESIGN DE
SUPPORT CYCLES SPÉCIFIQUES :
DESIGN, DIMENSIONS.**

VELOBAR*

Code		
VELOBAR 750*	1-2	750 X 1050
VELOBAR 1500*	2-4	1500 X 1050



* Sur commande ◦ Under request ◦ Bajo pedido ◦ auf Bestellung



Buff'Hyères

Collectivités

MOBILIERS & AMÉNAGEMENTS URBAIN

06 32 46 92 74 - MOBILIER@BHC83.FR

112